

AugerPrime Upgraded Electronics

G. Marsella^{a,b,*} on behalf of the Pierre Auger^c
Collaboration

^a*Università degli Studi di Palermo, Dipartimento di Fisica e Chimica "E. Segrè" Via delle Scienze ed. 17, 90128 Palermo, Italy*

^b*INFN Sezione Catania, Via S. Sofia, 64, 95125 Catania, Italy*

^c*Observatorio Pierre Auger, A. San Martín Norte 304, 5613 Malargüe, Argentina
E-mail: spokespersons@auger.org*

AugerPrime

- In 2015 Upgrade proposed to enhance physics:
 - Addition of a plastic scintillator plane (SSD);
 - New Electronics
 - An additional small PMT (sPMT) in the WCD to increase the dynamic range;
 - The installation of an underground muon detector (UMD);
 - Radio Detector (RD) added on top of each Station.

Upgraded Unified Board

- Faster electronics:
 - 120 MHz 12 bits ADC;
- Xilinx Zync-7020 FPGA and associated Dual processor (Cortex A9 333 MHz ARM co-processor)
 - PetaLinux Operative System
- The 10 time faster CPU and factor 10 in memory allow more sophisticated local processing
-

Tests

The boards are produced in Italy by SITAEEL S.p.A

- The boards undergo 2 test phases:
 - Manufacturer Test
 - Environmental Stress Screening

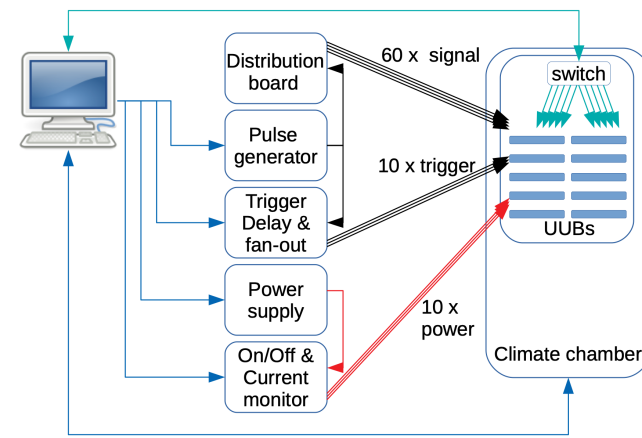
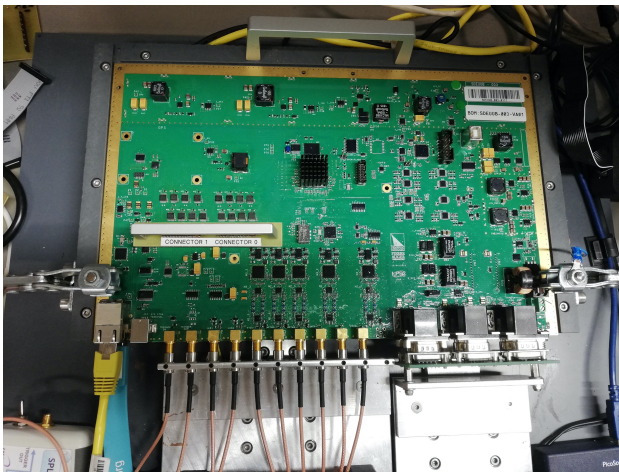

Deployment and Performances

- 81 Boards in the field in Argentina
 - New Detectors and new electronics are monitored in the field

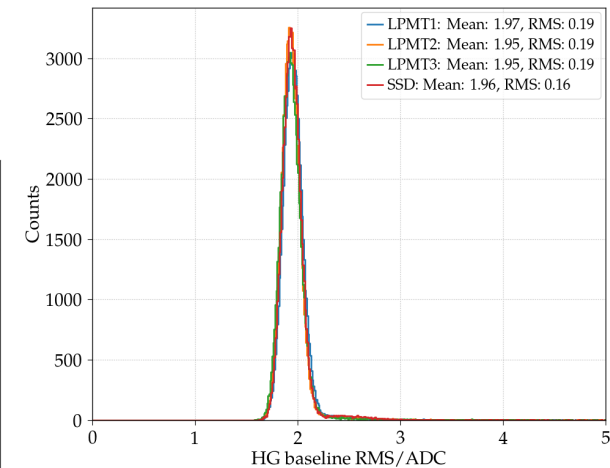
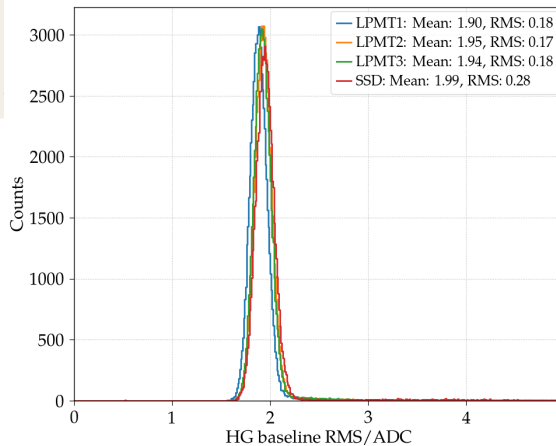
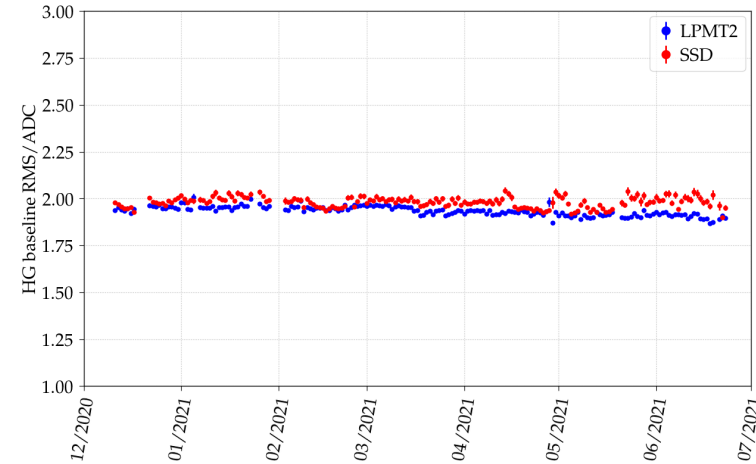
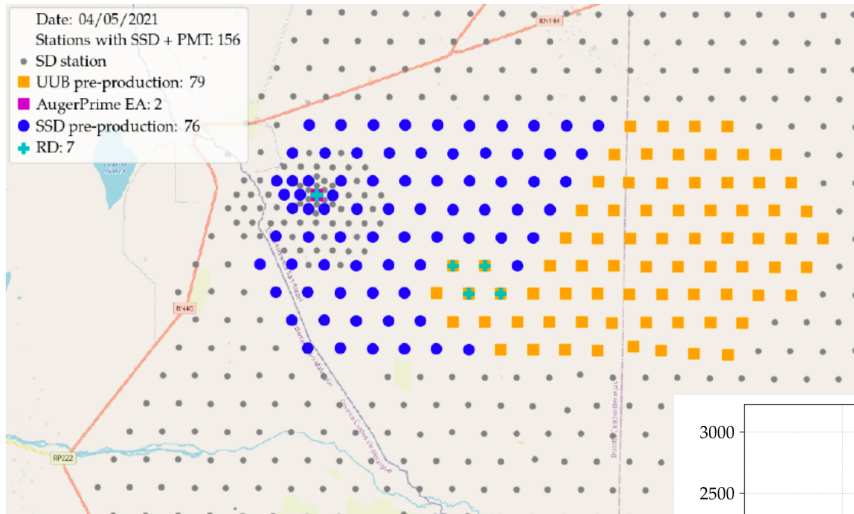

WCD, SSD and SPMT

- WCD in VEM, SSD in MIP

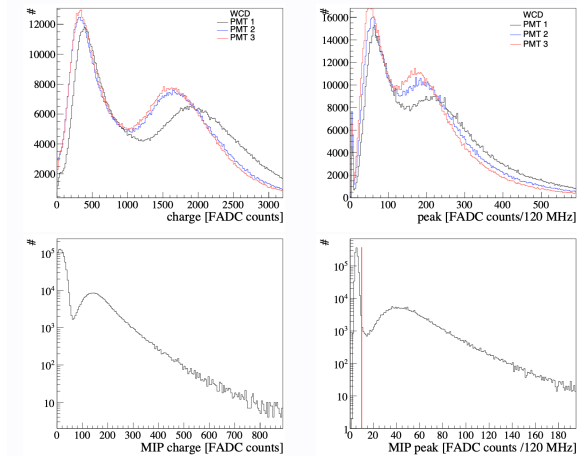

- Small PMT (SPMT) extension of dynamic range

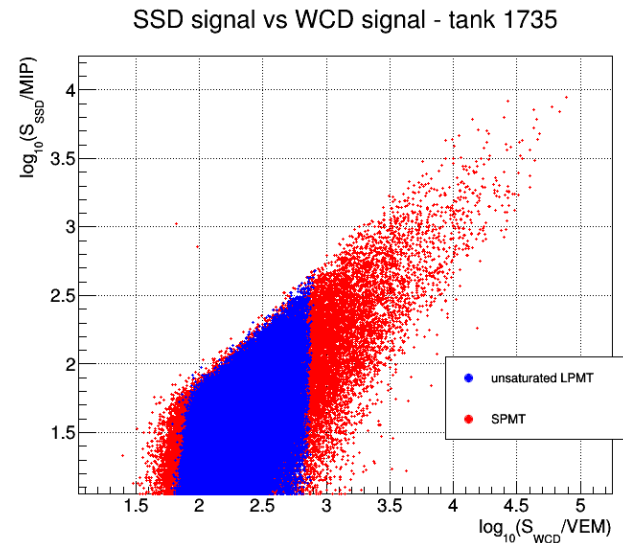
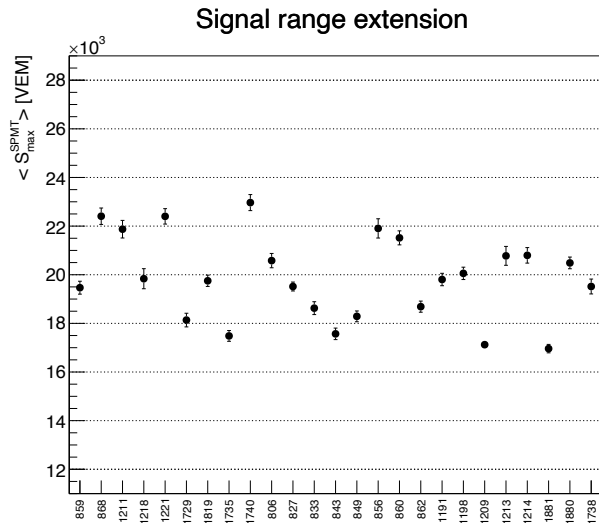

Conclusions

- AugerPrime is in its commissioning phase.
- The UUBs are in production
 - Already 81 boards are in Argentina
 - 84 more end of July 2021
 - 400 more are planned at the end of August 2021.
- The performances of the boards are stable and well within the design requirements.
- The process is going on as expected and we foresee the completion of the UUB deployment by the end of 2022